

Bahnhof »Susch«

»Susch« Station
Gare de »Susch«
Station »Susch«

POLA G

Art. Nr. 330999



Sa. Nr. 330 999 2

- (D)**
- Verwenden Sie nur POLA G-Cement.
 - Machen Sie sich vor dem Zusammenbau gut mit den Einzelteilen des Bausatzes vertraut. Trennen Sie die Einzelteile erst dann ab, wenn sie gebraucht werden.
 - Verwenden Sie beim Zusammenbau wenig Klebstoff. Sie werden dann mehr Freude an einem sauberem Modell haben.
 - Sollte trotz werkseitiger sorgfältiger Prüfung ein Teil fehlen oder fehlerhaft sein, kreuzen Sie bitte das Teil in der Anleitung an und schicken Sie diese bitte an:
Gebr. FALLER GmbH, Abt. Kundendienst, kundendienst@faller.de, Kreuzstraße 9, D-78148 Gütenbach.
Sie erhalten dann umgehend Ersatz.
- (GB)**
- Use POLA G-Cement only.
 - Familiarize yourself well with the components of the kit before assembly. Do not break off the components until the moment you need them.
 - Use glue sparingly on assembly, then you will enjoy your neat model even more.
 - If a part is missing or defective despite careful checking at the factory, please mark the part concerned in your instructions and send it to:
Gebr. FALLER GmbH, Abt. Kundendienst, kundendienst@faller.de, Kreuzstraße 9, D-78148 Gütenbach, Germany.
You will receive replacement promptly.
- (F)**
- N'utilisez que la colle POLA G -Cement.
 - Avant l'assemblage, familiarisez vous avec les différentes pièces du jeu de construction. Ne séparer les pièces particulières qu'au moment de les utiliser.
 - Utiliser aussi peu de colle que possible pour l'assemblage, vous aurez d'autant plus de plaisir avec un modèle propre.
 - Si, malgré un contrôle soigneux à l'usine, une pièce devait manquer ou être défectueuse, marquer cette pièce d'une croix dans les instructions et envoyer ces dernières à:
Gebr. FALLER GmbH, Abt. Kundendienst, kundendienst@faller.de, Kreuzstraße 9, D-78148 Gütenbach (R.F.A.).
On vous la remplacera aussitôt.
- (NL)**
- Gebruik uitsluitend POLA G -cement.
 - Zorg da u vóór de montage goed weet uit welke onderdelen het bouw pakket bestaat. Maak de onderdelen pas los als u ze gaat gebruiken.
 - Gebruik bij de montage slechts weinig lijm. U zult dan meer plezier beleven aan een schoon model.
 - Mist u ondanks zorgvuldige fabrikantencontrole toch een onderdeel of is een onderdeel beschadigd, kruis dan het desbetreffende onderdeel aan in de handleiding en stuur dit s.v.p. aan:
Gebr. FALLER GmbH, Abt. Kundendienst, kundendienst@faller.de, Kreuzstraße 9, D-78148 Gütenbach, Duitsland.
Het wordt dan direct vervangen en naar u opgestuurd.



2

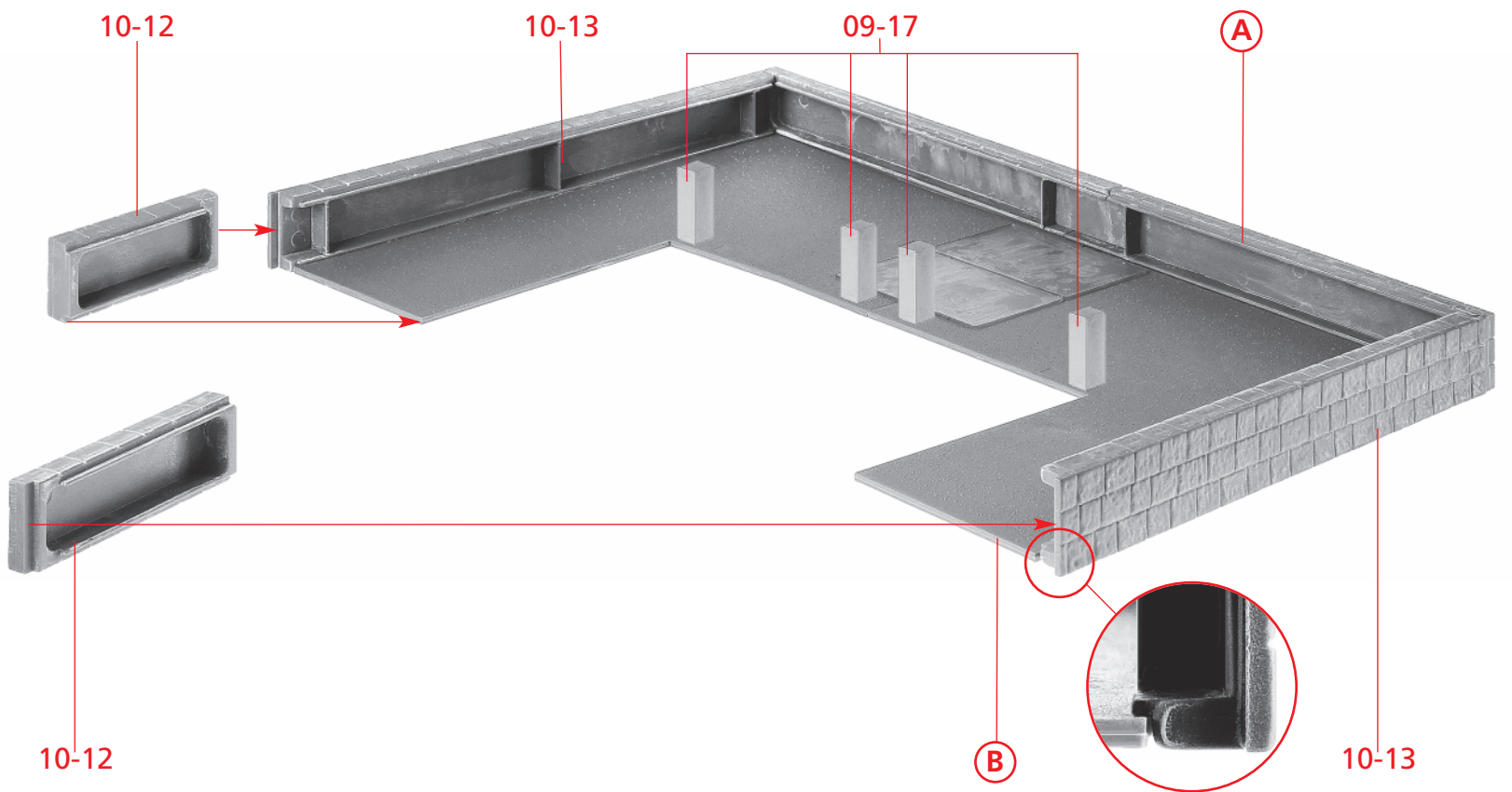
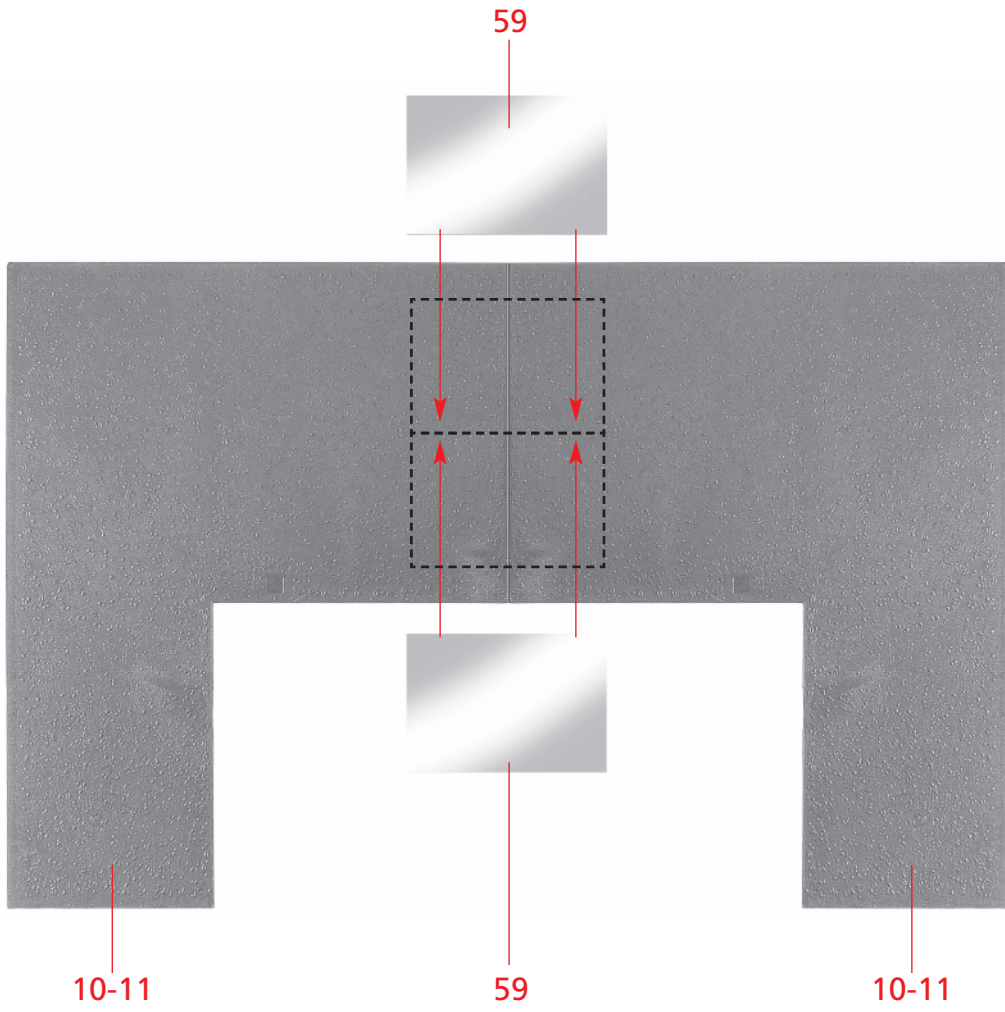
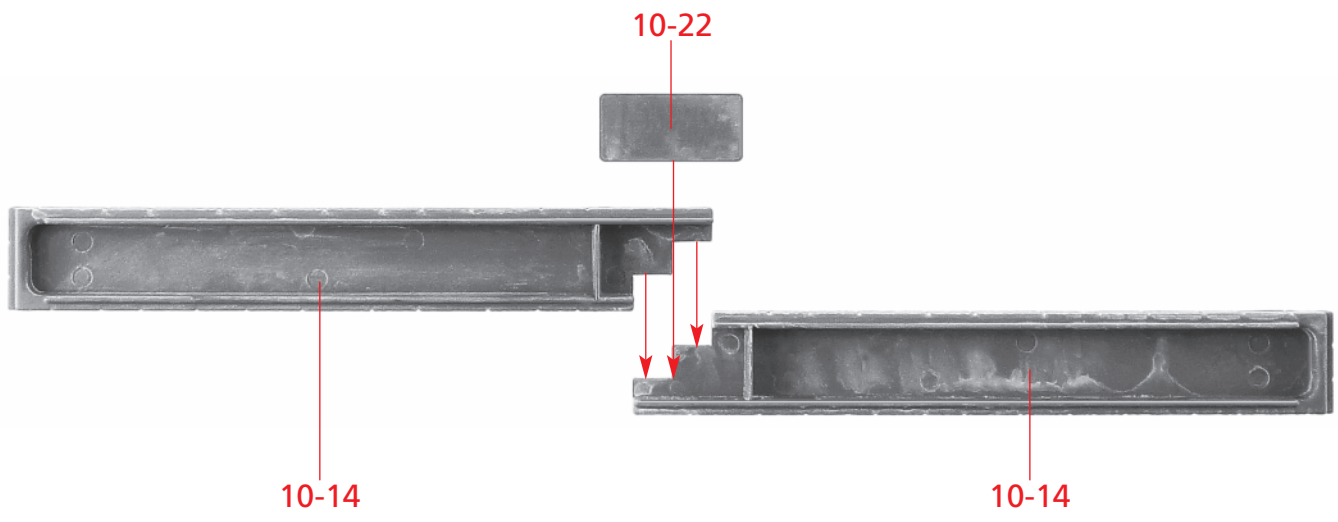

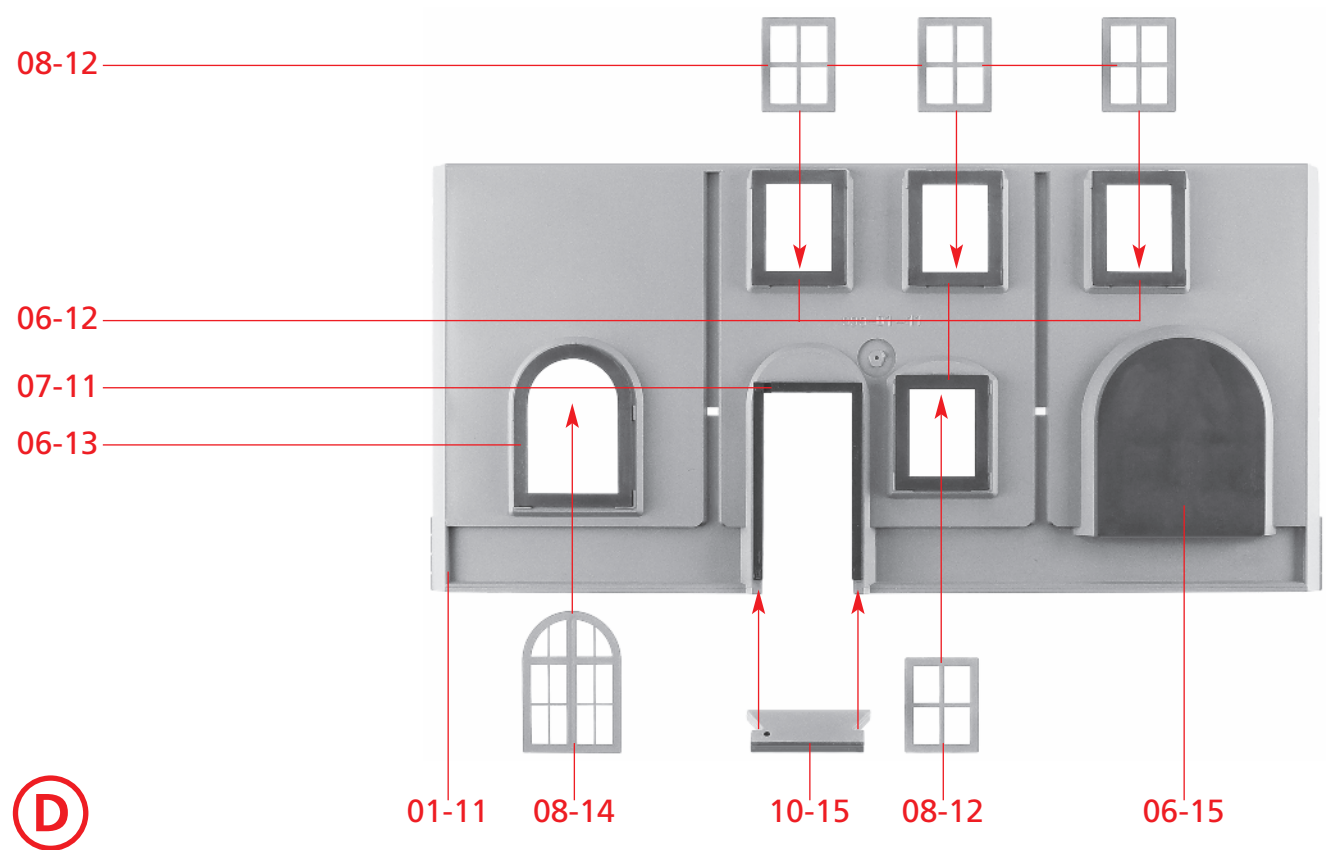

D

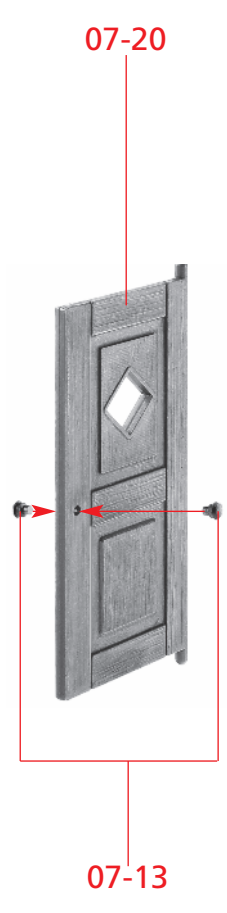

E

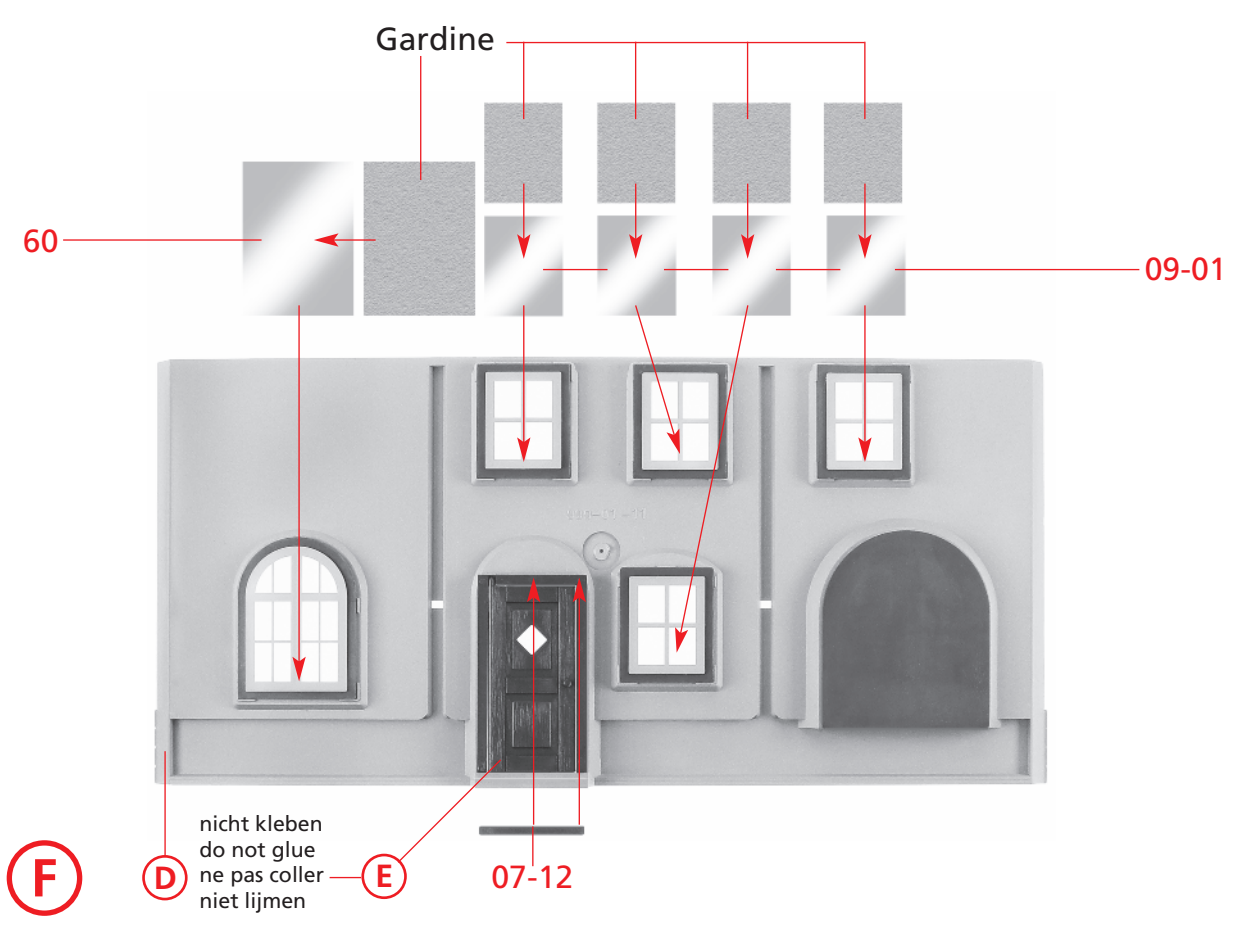

F

D

E

Deco



G

03-16

03-11

F

03-13

4

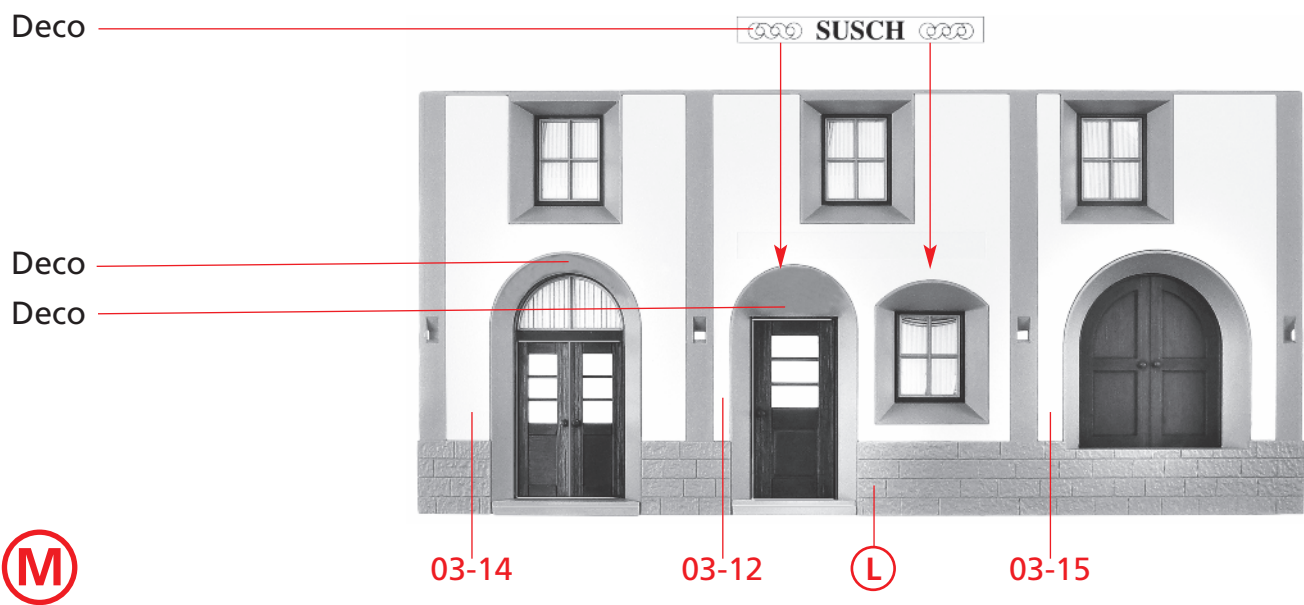
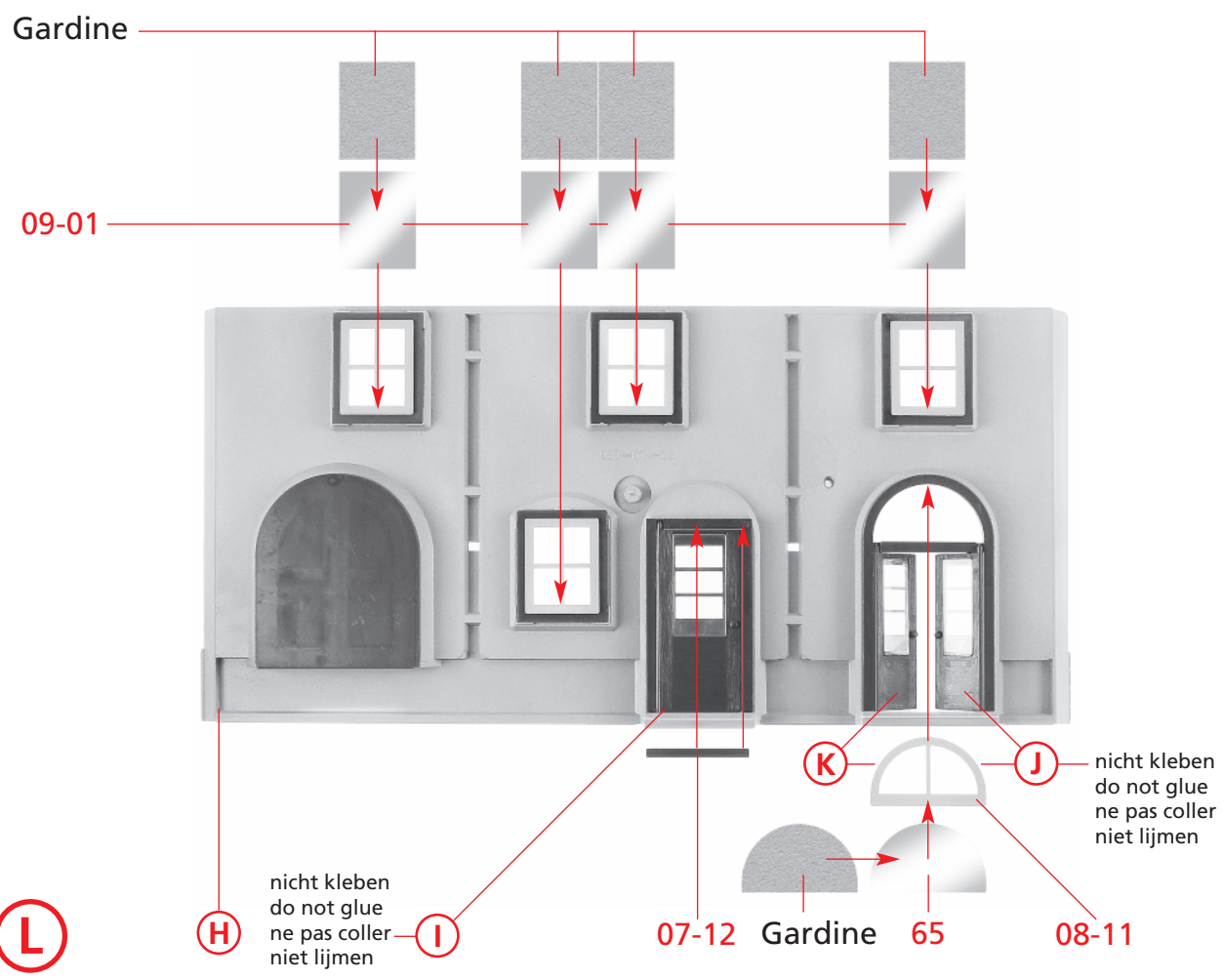
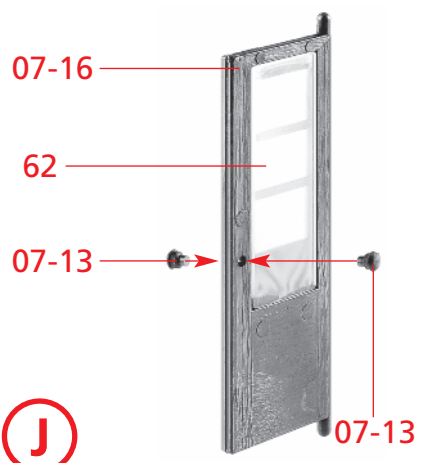
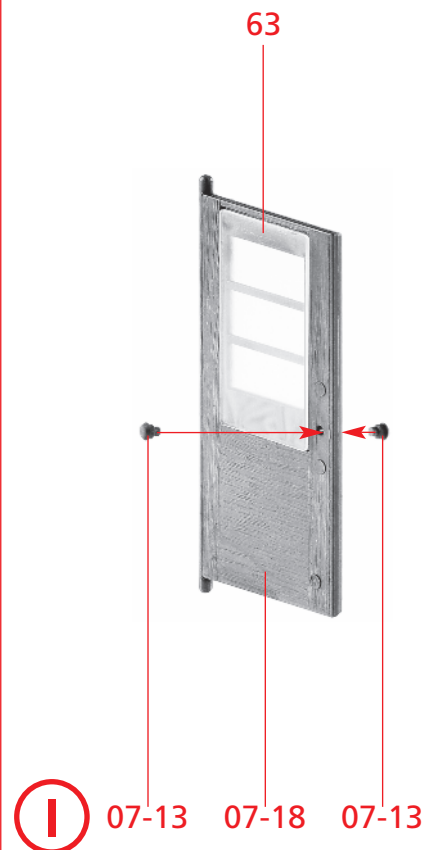
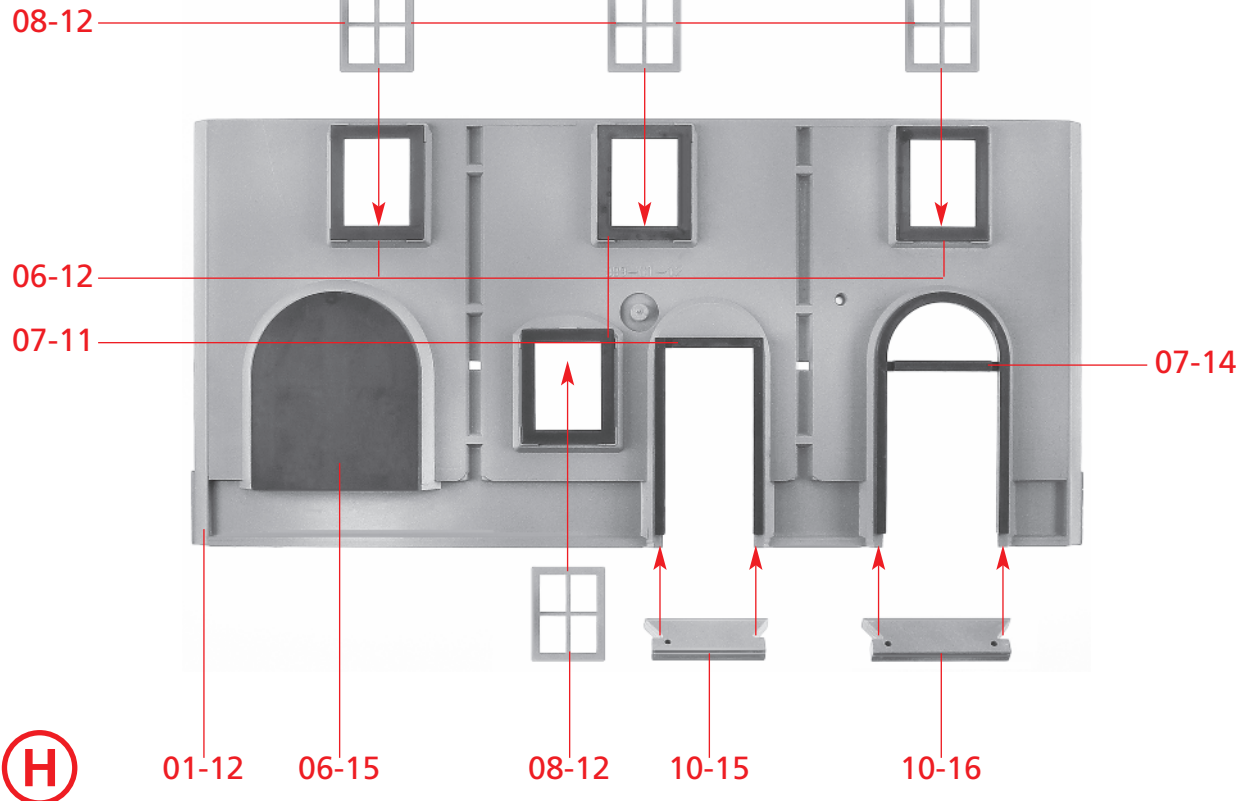

08-12

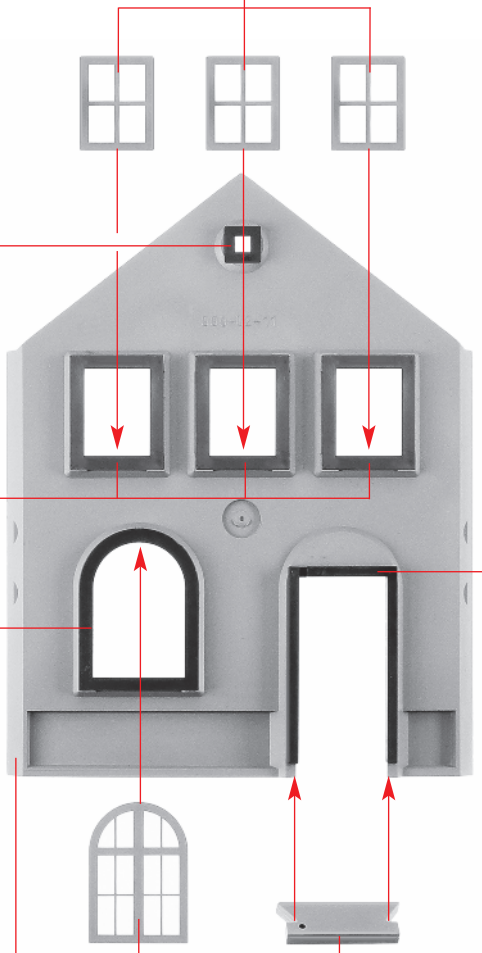

06-21

06-12

06-13

07-11

02-11

08-14

10-15

N

09-02

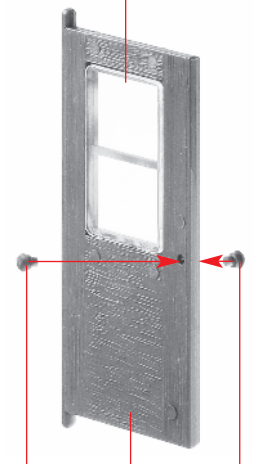

07-13

07-19

07-13

O

Gardine

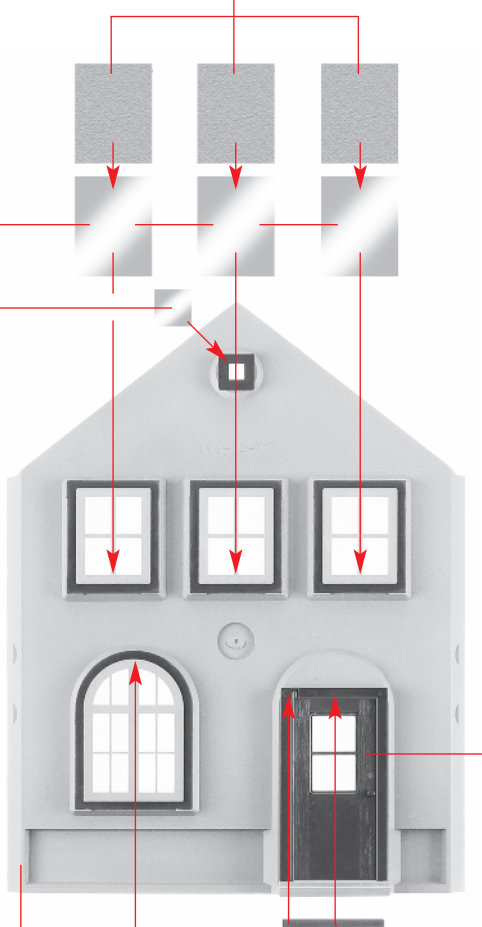

09-01

09-03

O

P

N

60

Gardine

07-12

nicht kleben
do not glue
ne pas coller
niet lijmen

Deco

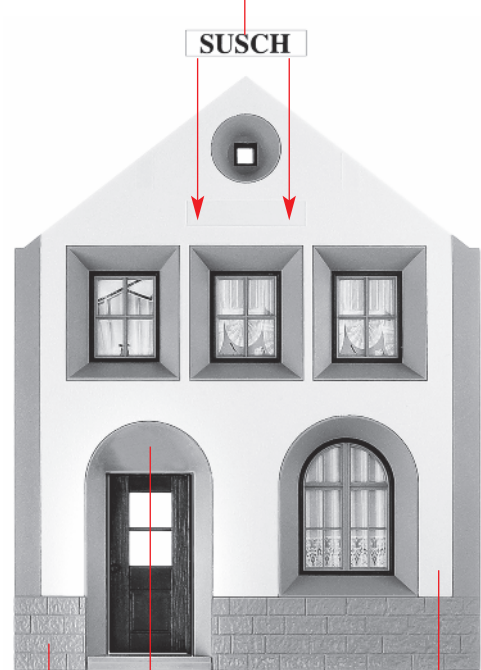

SUSCH

P

Deco

04-11

Q

6

08-12 06-21 08-12

Gardine

Gardine

Deco

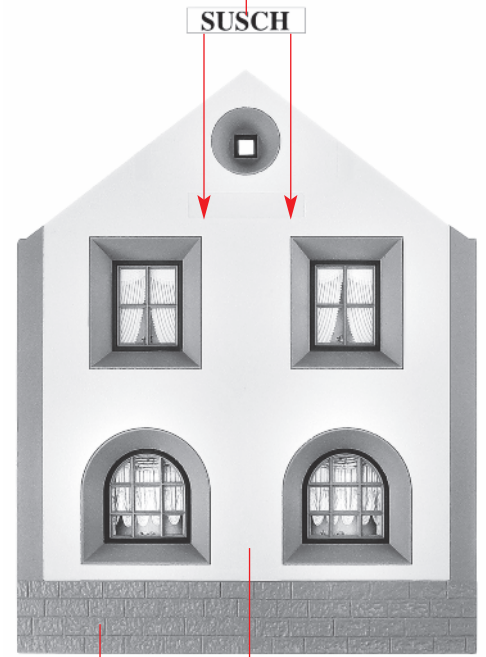
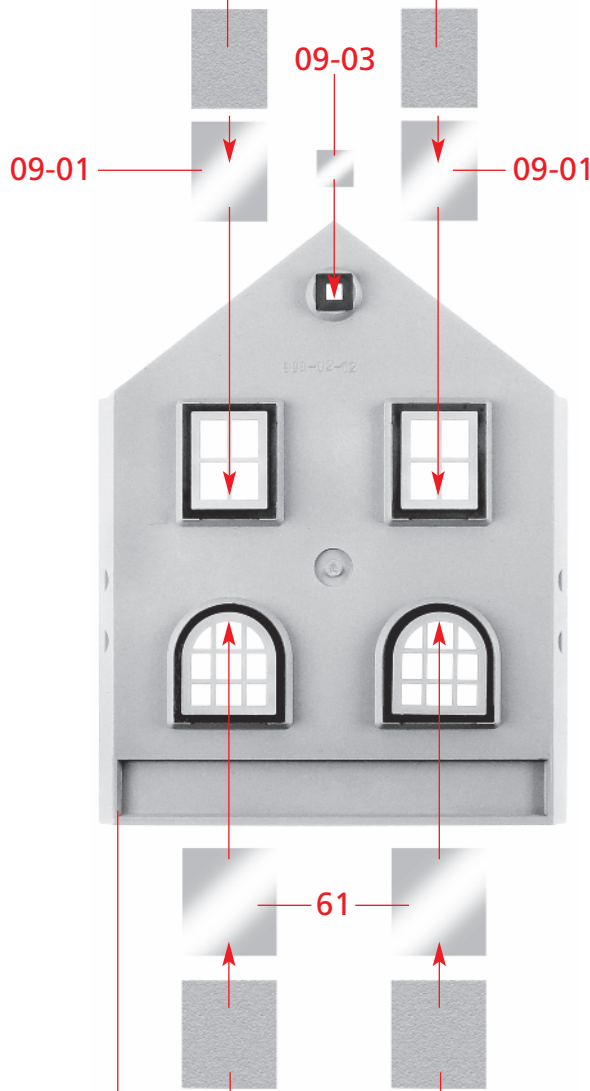
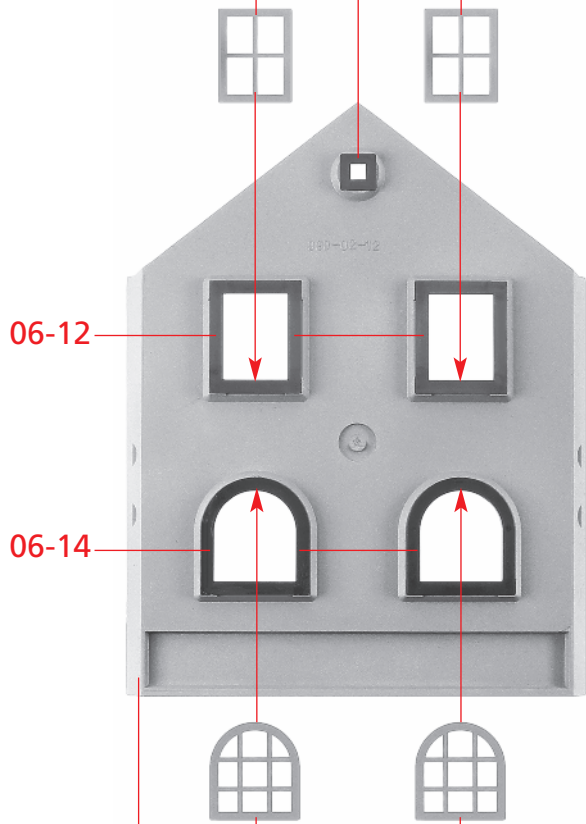

(R) 02-12 08-13 08-13

(S) **(R)** Gardine Gardine

(T) **(S)** 04-12

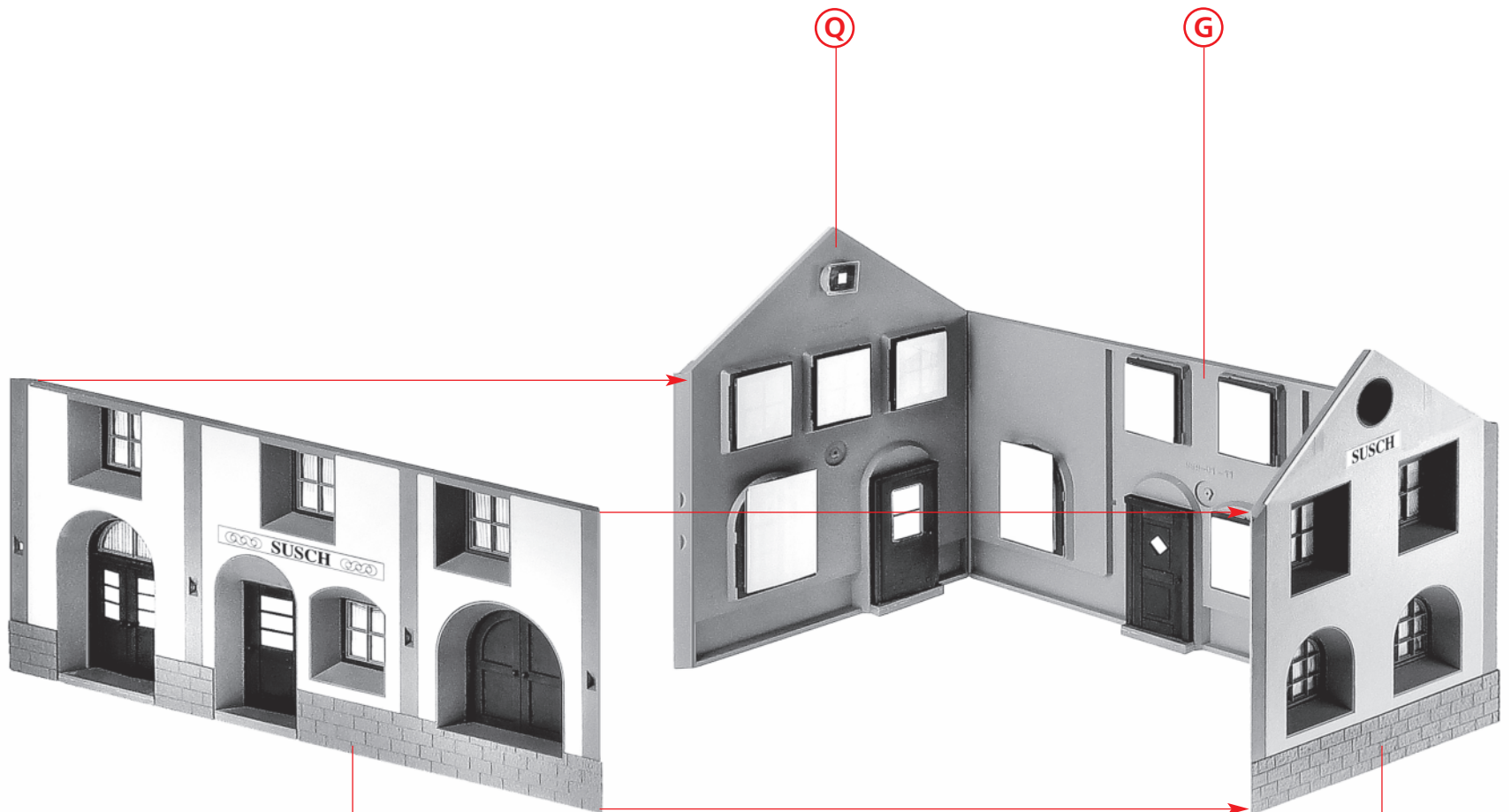

(U)

(M)

(T)

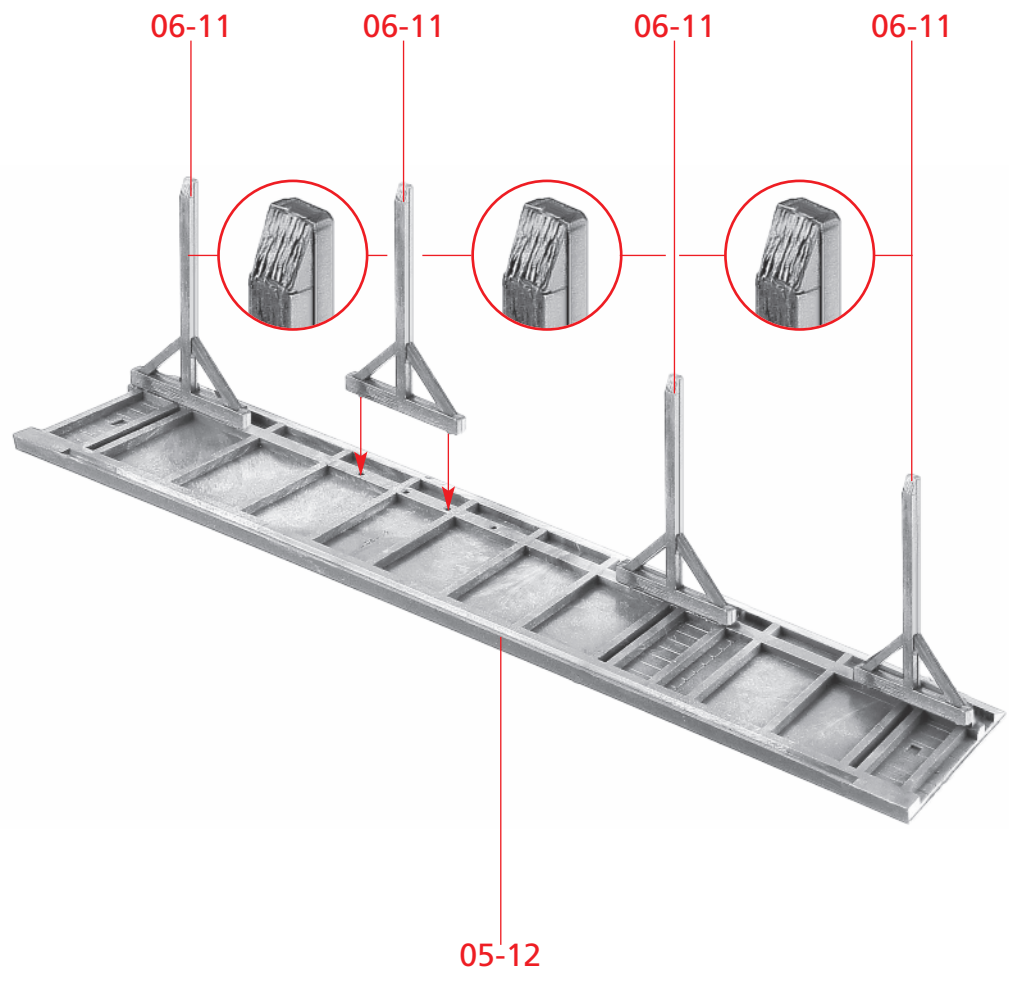
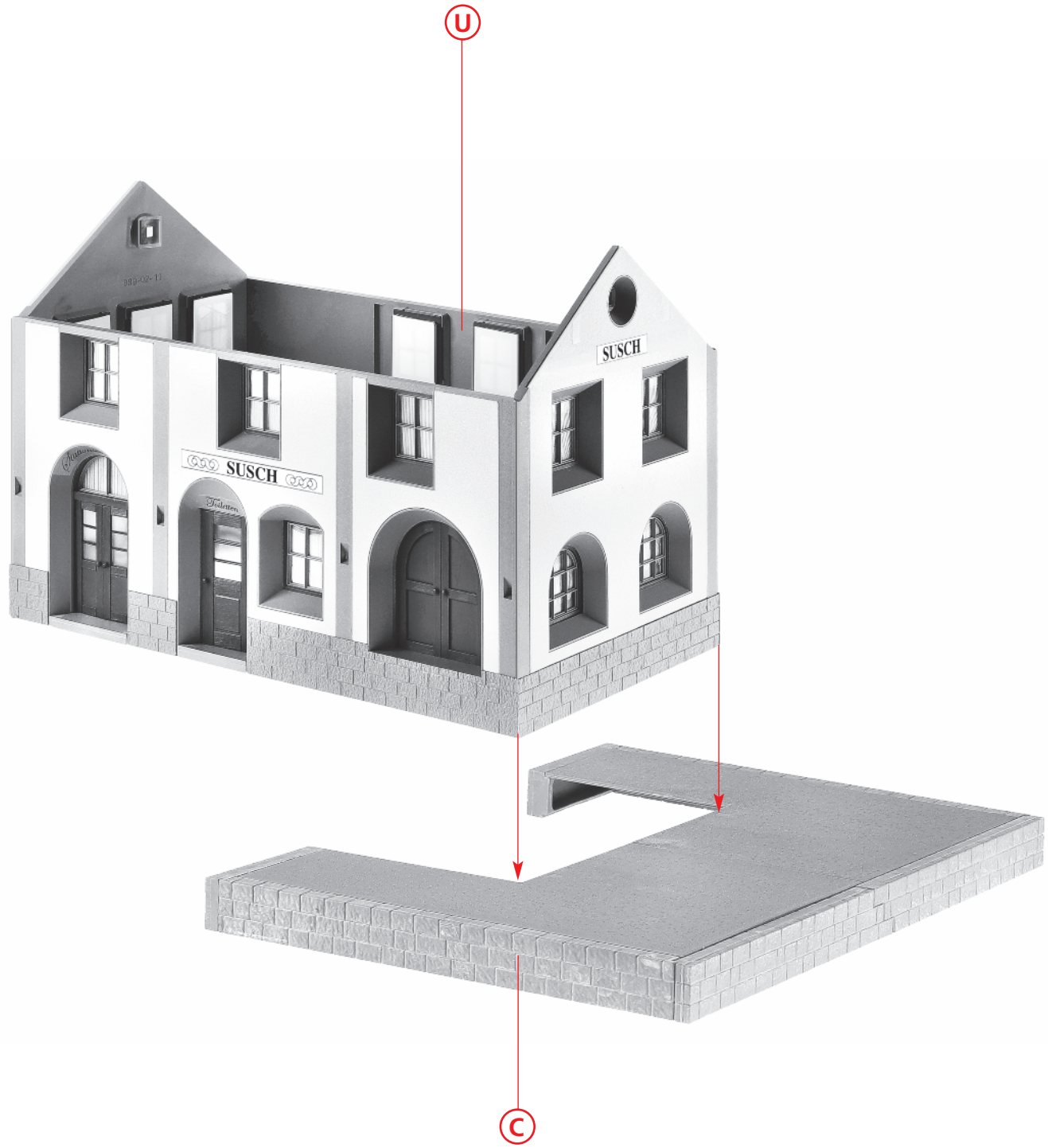

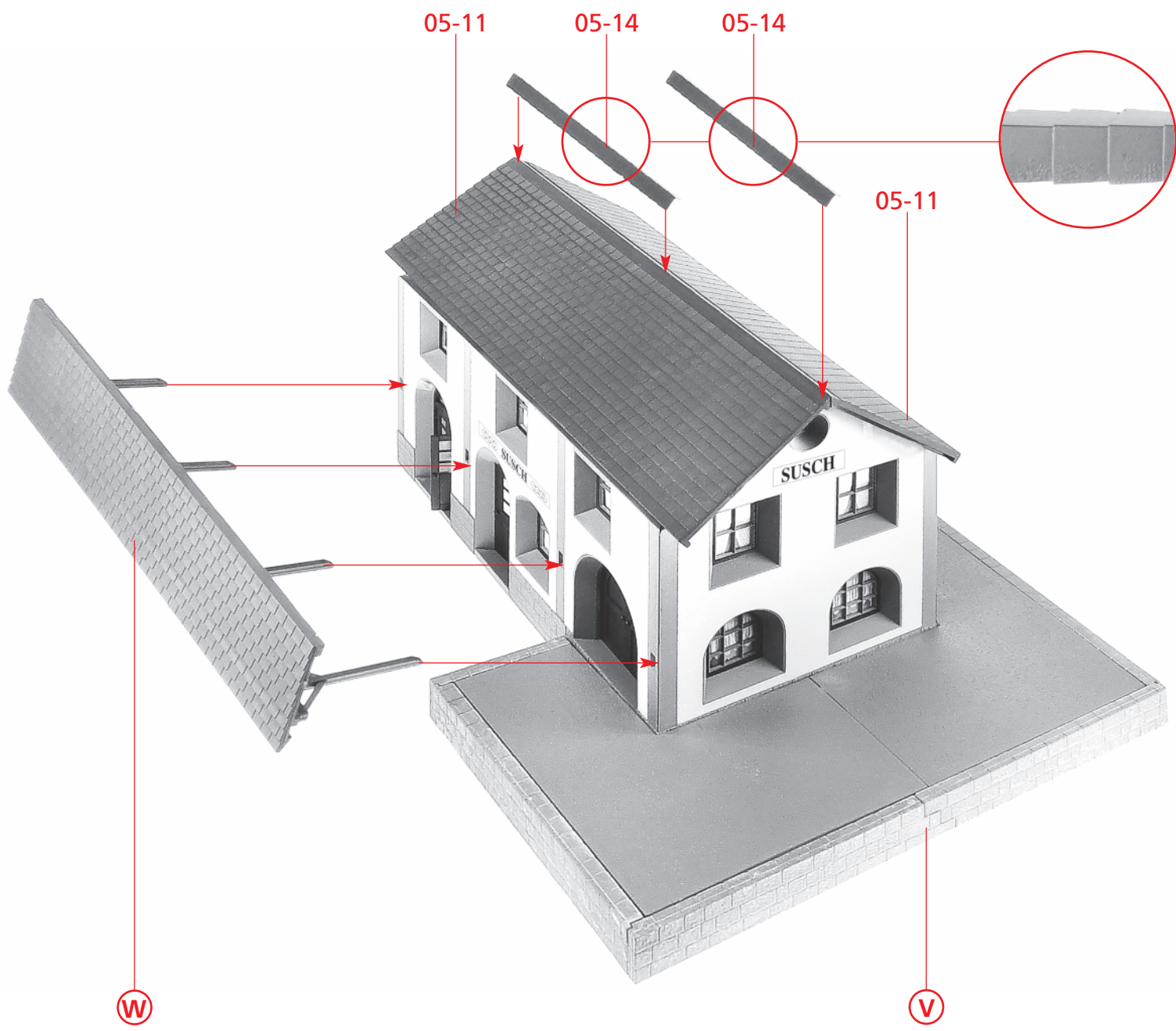

X

W

V

Y

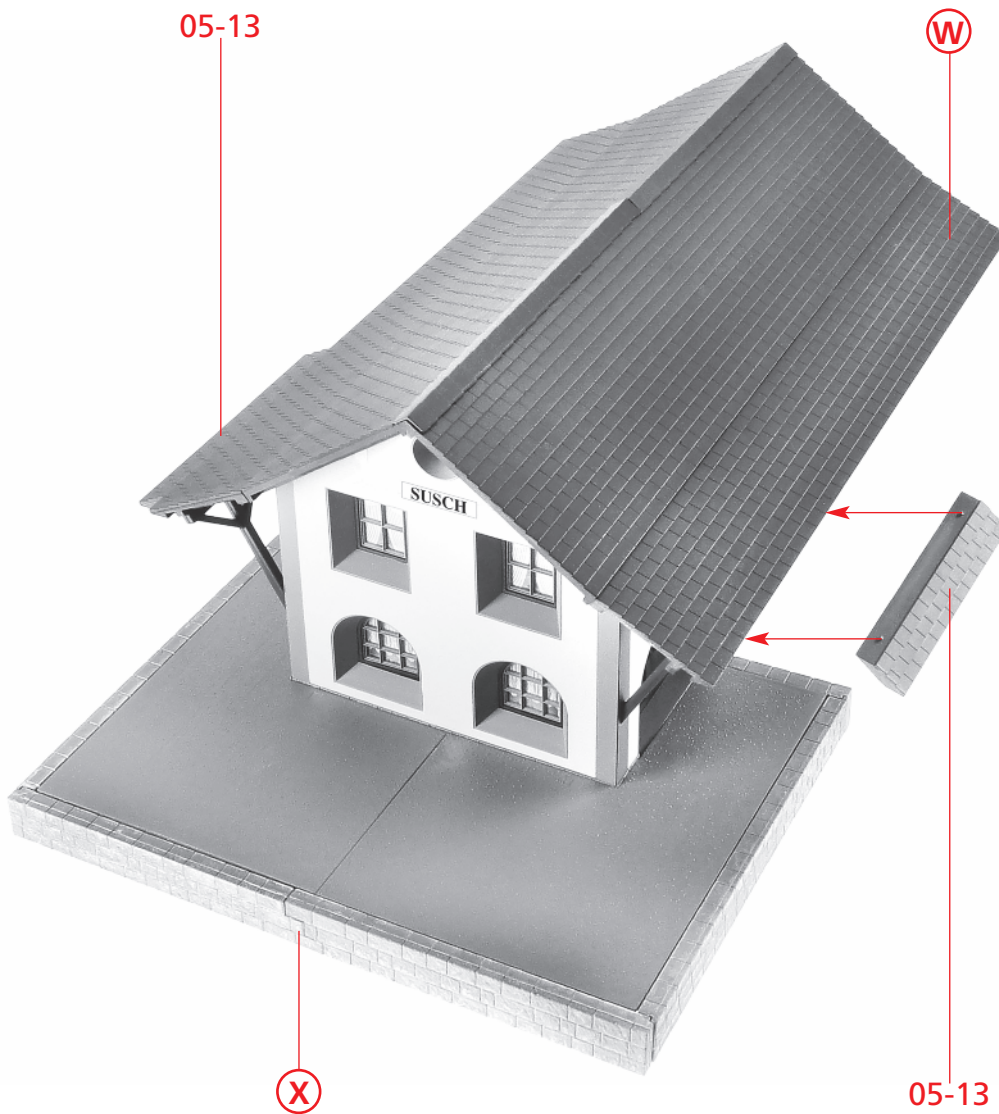

05-13

W

X

05-13

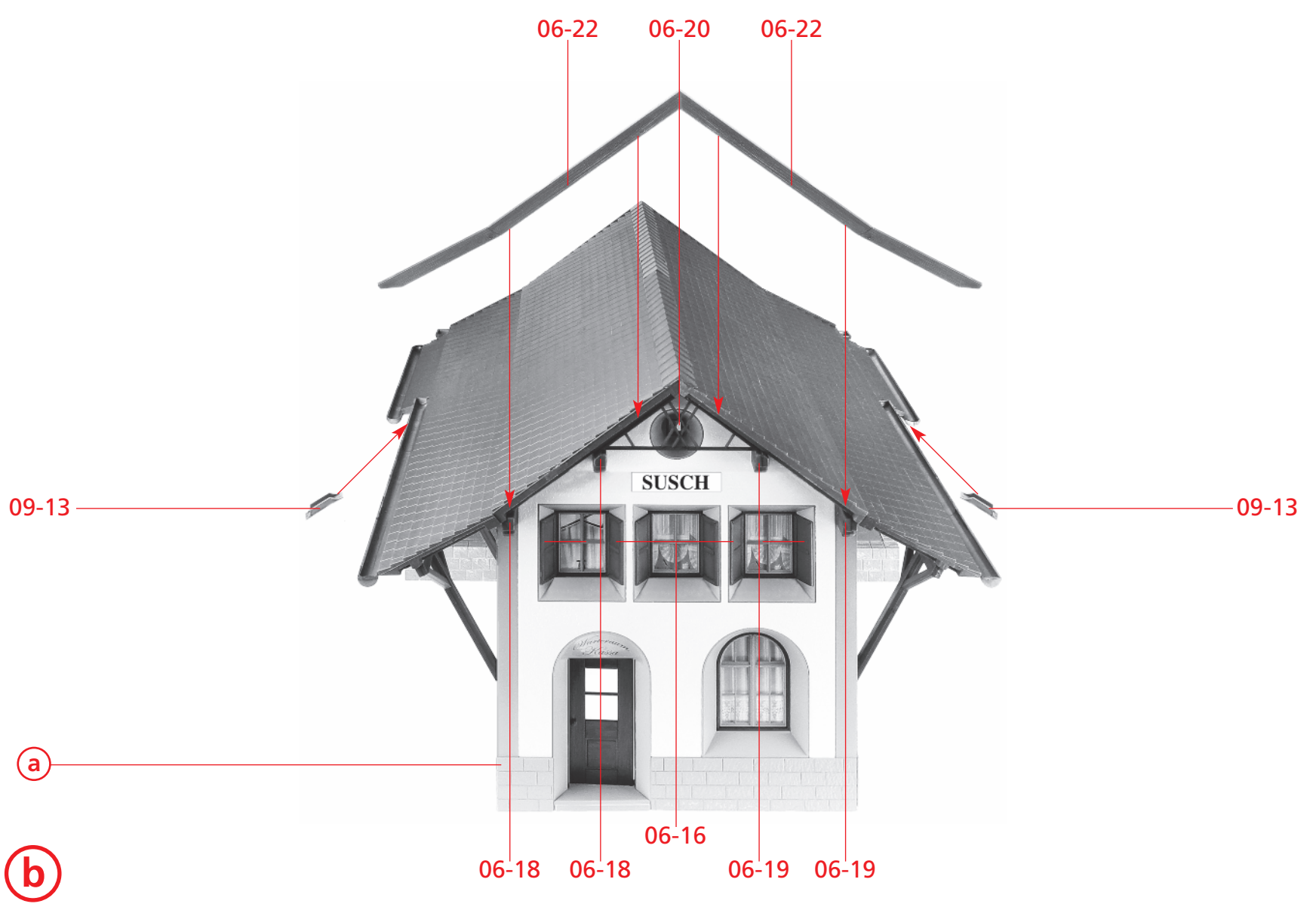
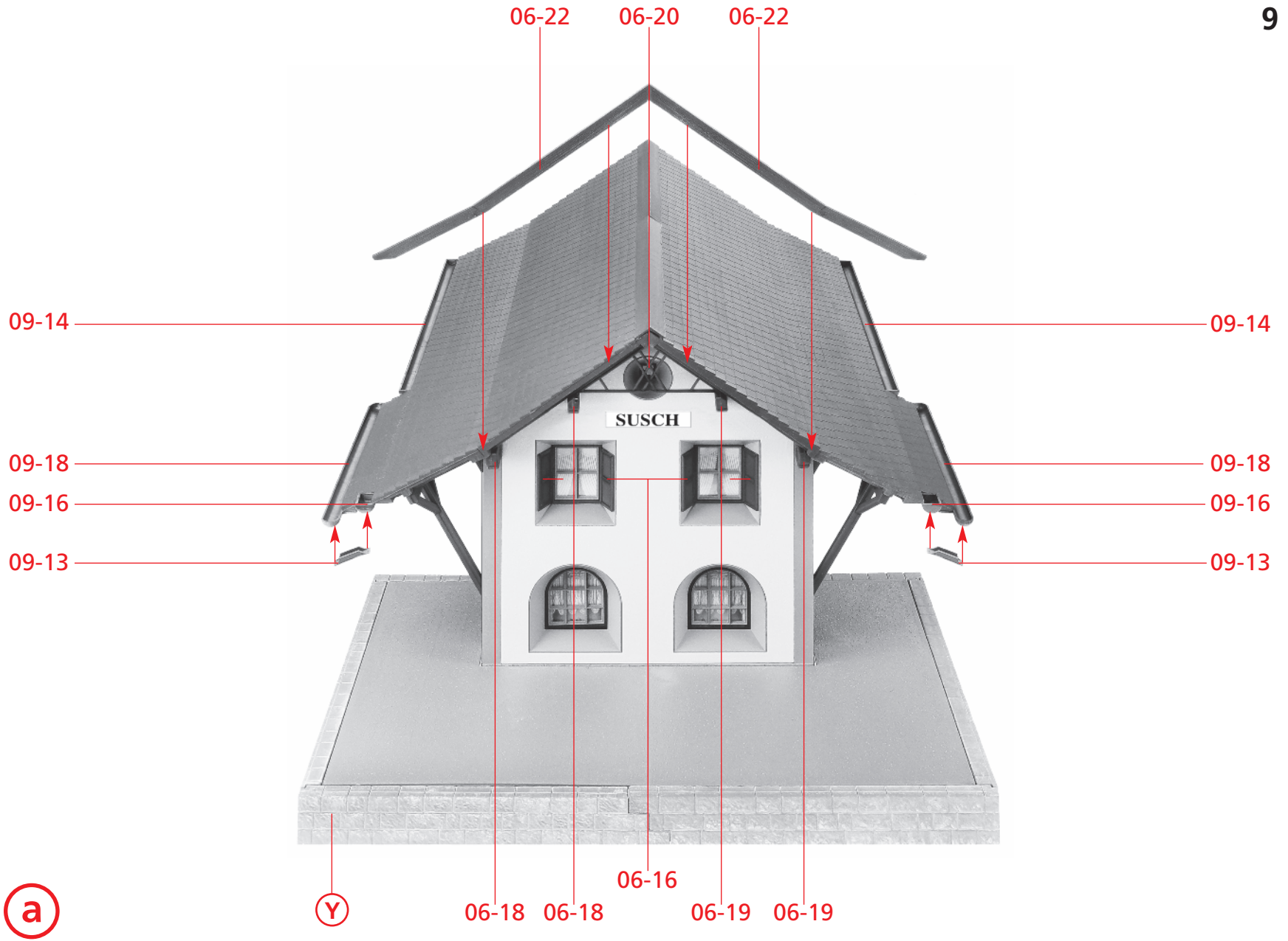

10

10-19 10-20 10-18

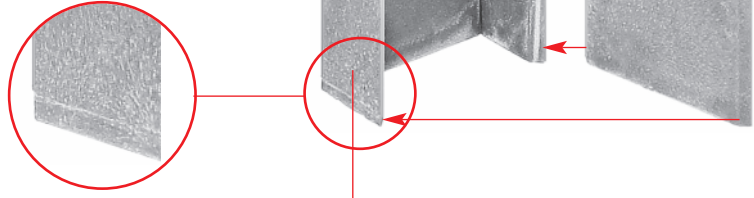

10-17

(c)

10-21

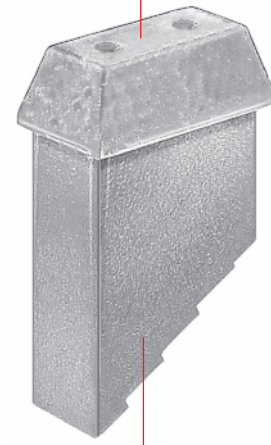

(c)

(d)

06-23

(d)

06-23

09-19

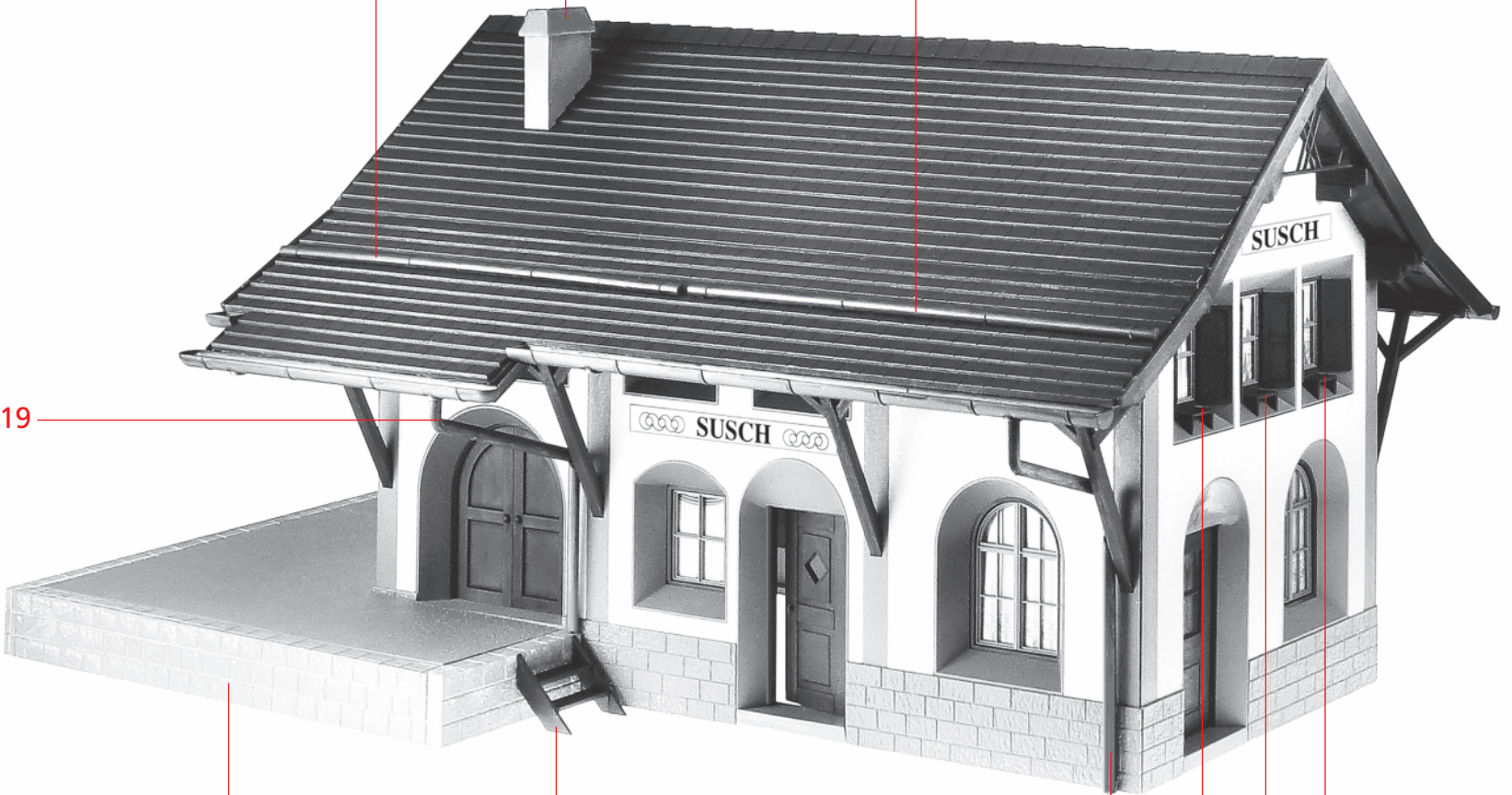

(b)

06-24

09-20

06-17

(e)

Deco

Deco

PVC-Platte

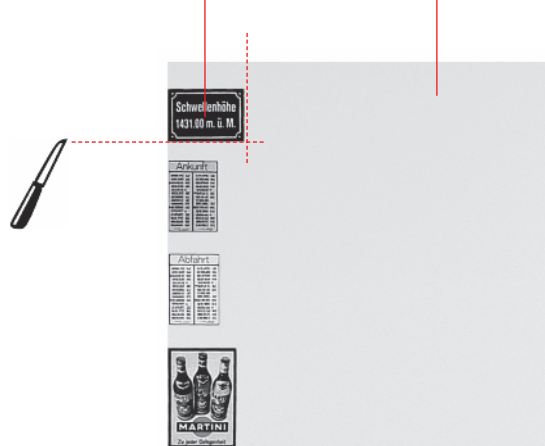

f

g

05-13

05-13

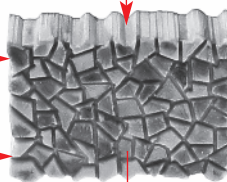
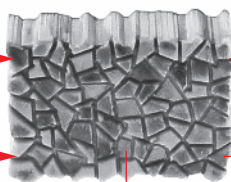
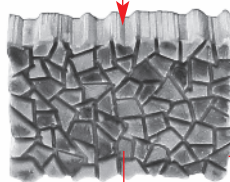
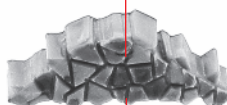
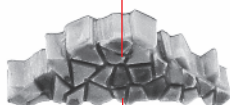

05-15

05-15

05-15

05-15

h

Inhalt Tüte Contents bag
Contenu sachet Inhoud zakje

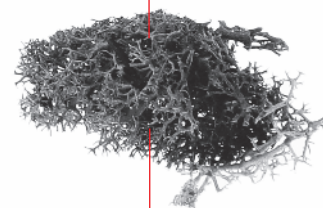

i

6 x

05-14

06-23

g

06-17

06-23

09-12
09-11

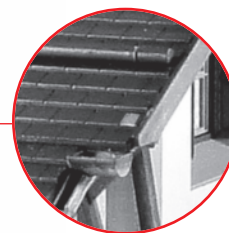
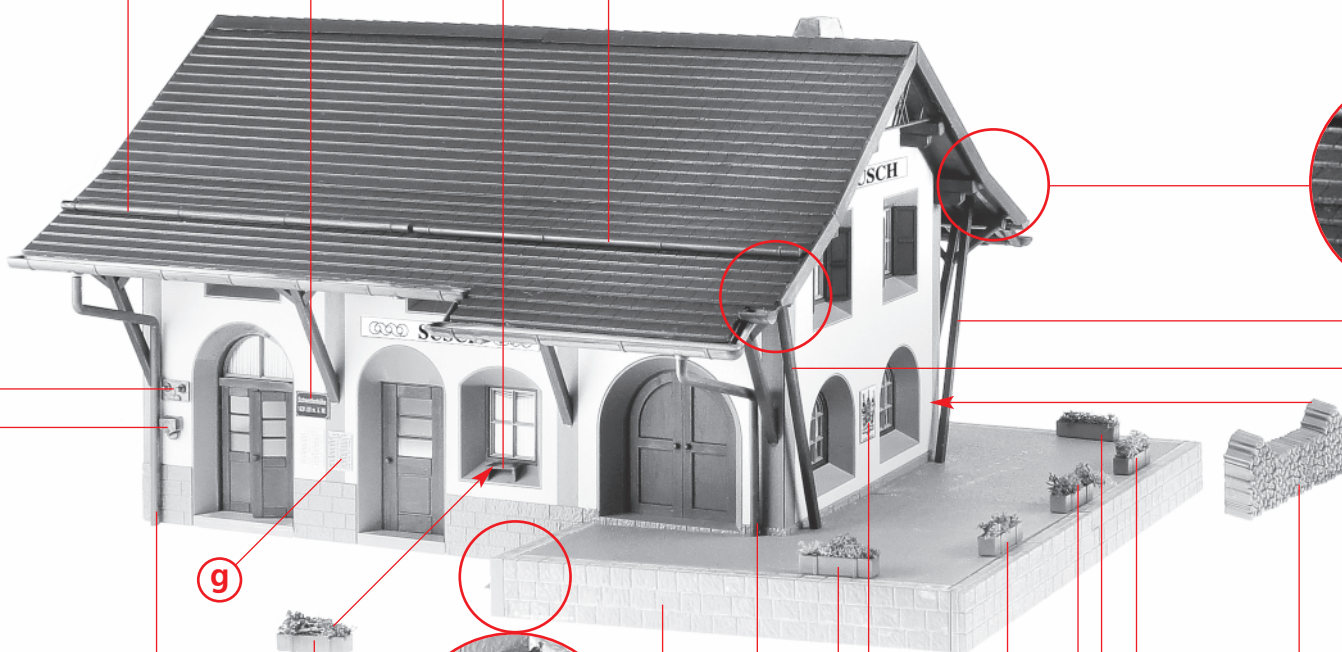

06-16

06-16

g

g

j

09-20

i

06-24

e

09-19

i

h

